

Normalbeton - Schalungssteine

	R 17,5 NB	R 20 NB	R 24 NB	R 30 NB	Drainagestein
Höhe / Länge in mm	250 / 500	250 / 500	250 / 500	250 / 500	10 / 248 / 500
Gewicht in Kg / Stein	20,3	23,2	23	29,5	14,8
Wandgewicht ohne Putz KN /qm	4,025	4,600	5,520	6,900	-
Steinbedarf pro qm	8	8	8	8	8
Betonfüllung in ltr pro qm	103	114	160	195	-
K- Wert mit Putz *	2,44	2,37	2,27	2,13	-
Brandschutz	Brandwand 2 x 17,5 cm	Brandwand	Brandwand	Brandwand	-
Schalldämmmaß (R'dB)	54	55	59	60	-
Sondersteine	Kombi/ ERG 7,5	NL/ ERG 5	1/4+3/4L/ HL / S	EB / H / HL	-
Normalpalette Inhalt	48N+12Kombi	36N+12NL+12Kombi	48N	36N	72
Sonderpalette Inhalt	-	-	36HL +12 1/4+3/4L	12H + 12HL + 12EB	-
Zusatzsteine	ERG 7,5	ERG 5	Schlitzsteine	-	-
Paletteninhalt Normalpalette qm	7,5	7,5	6	4,5	9

* Werte mit 15 mm Innenputz und 30 mm Außenputz

Stand 4/2014

Sondersteine

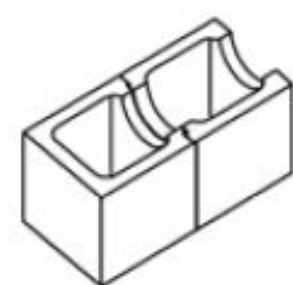

Leibungshalbstein HL

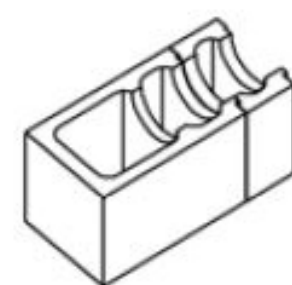

Leibungsstein 1/4 + 3/4 L

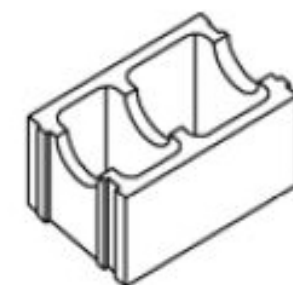

Eckstein EB

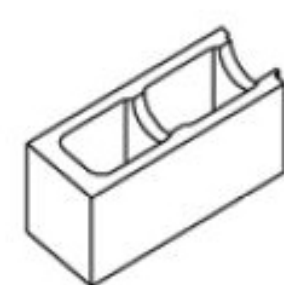

Leibungsstein NL

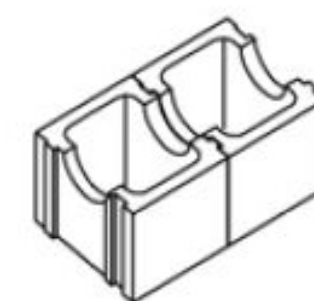

Halbstein NL

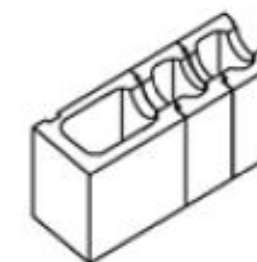

Kombistein

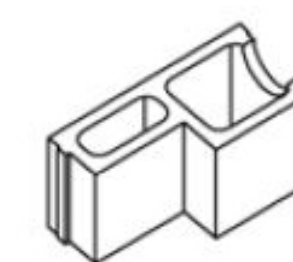

Schlitzstein S



Ergänzungsstein ERG